



中山市川狼五金制品厂

ZHONG SHAN CHUAN LANG LIGHTING CO., LTD

型号: 50W 模组玻璃透镜款 - 200W

外观图

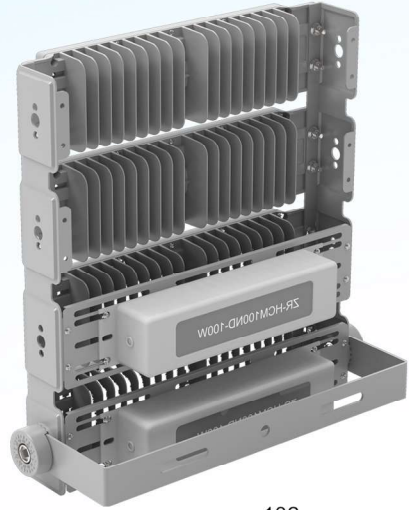

线条图

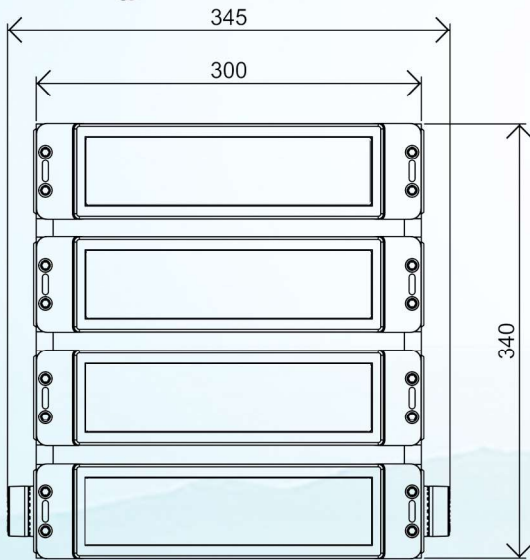

主视图

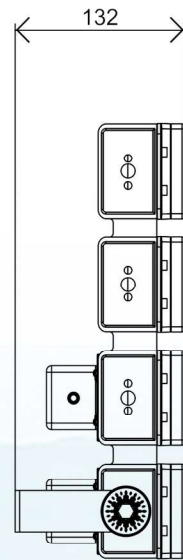

左视图

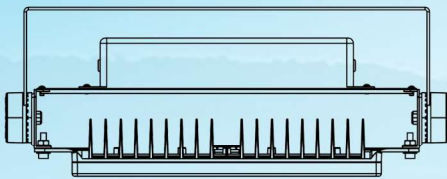

俯视图



透视图

灯体尺寸: L345*W340*H132

铝基板-反光纸

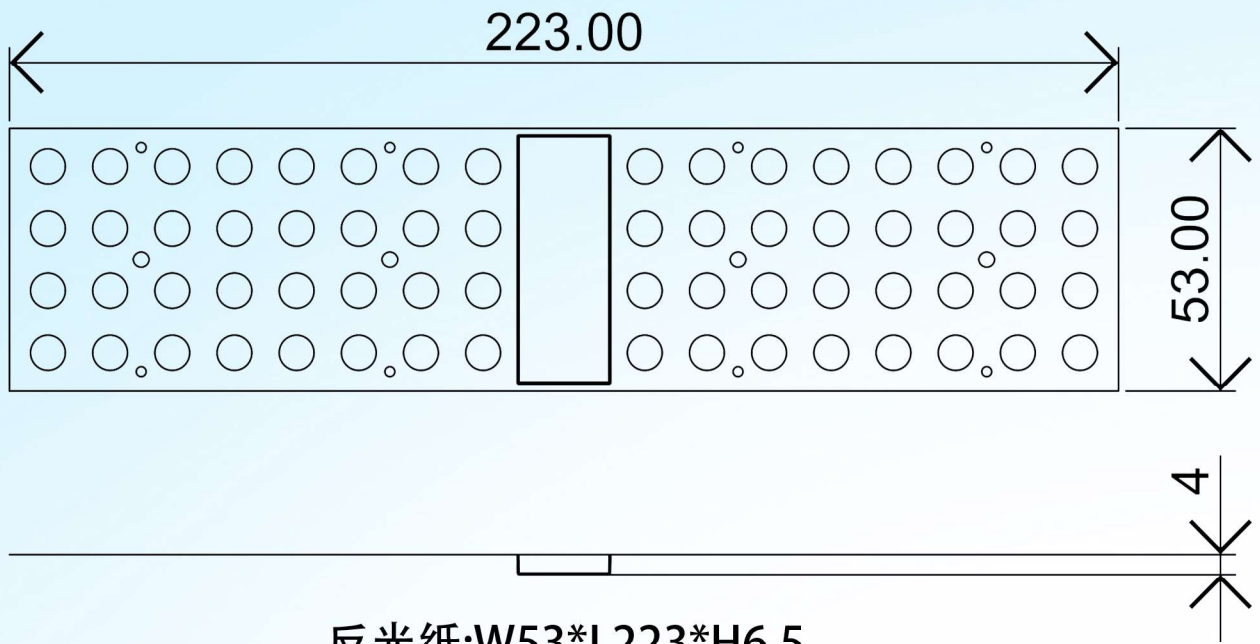

反光纸:W53*L223*H6.5

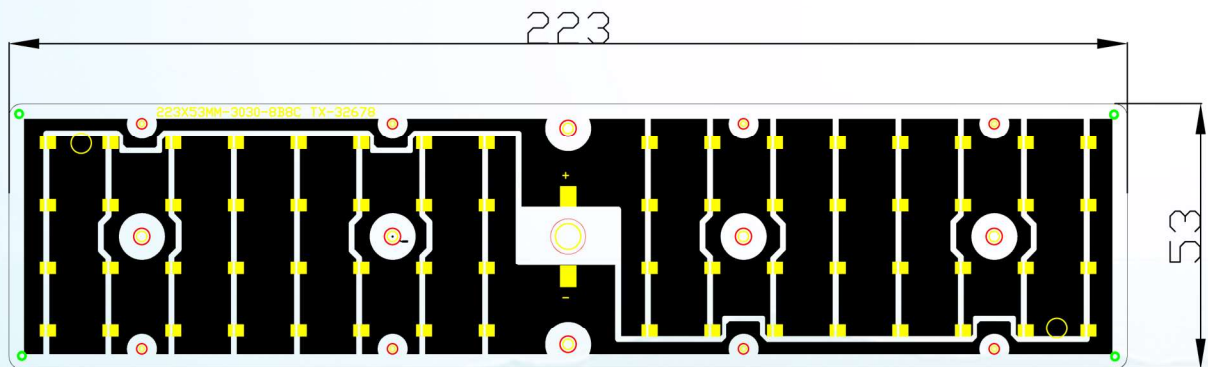

铝基板: W53*L223*1.0 8B8C 3030

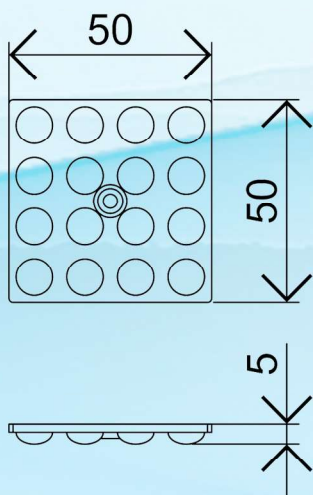

16合一透镜: 90度

尺寸孔位

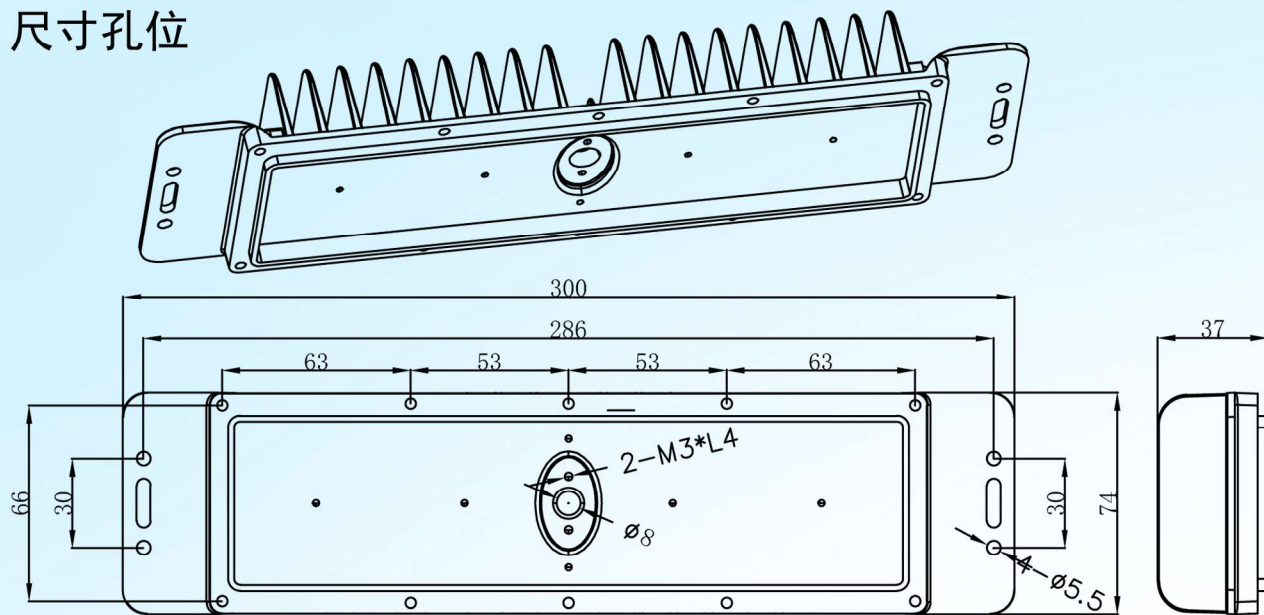

压铸铝灯体

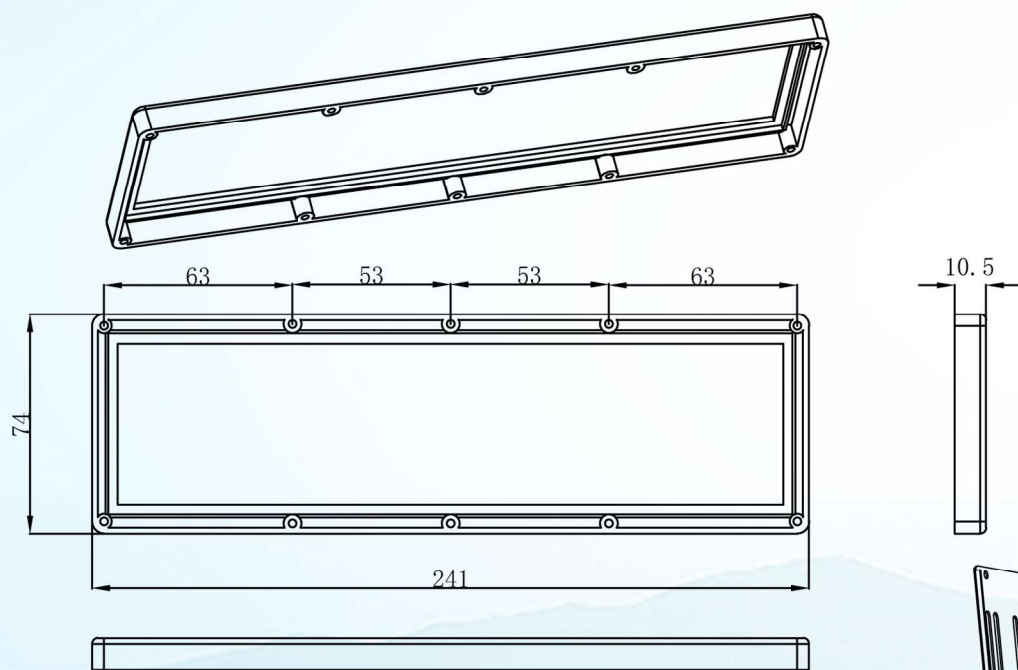

压铸铝面框

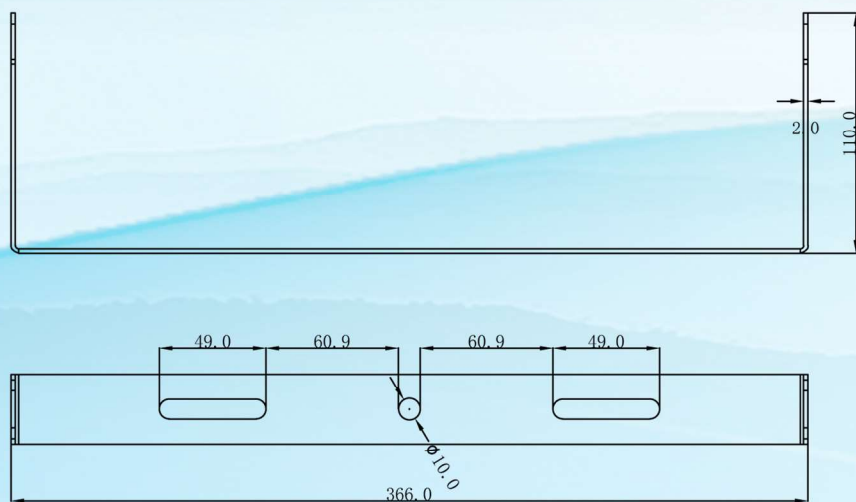

支架孔位

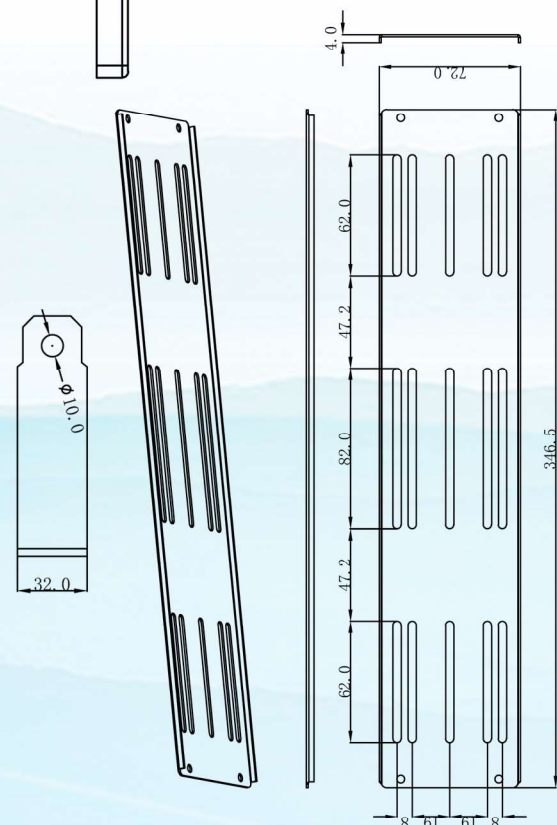

电源板孔位

爆炸图

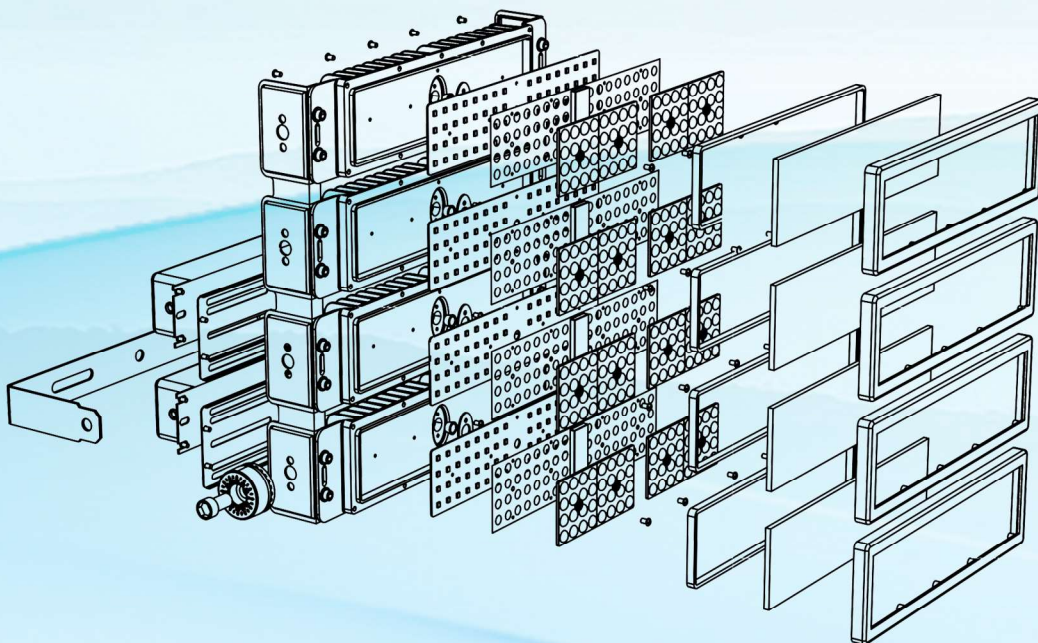
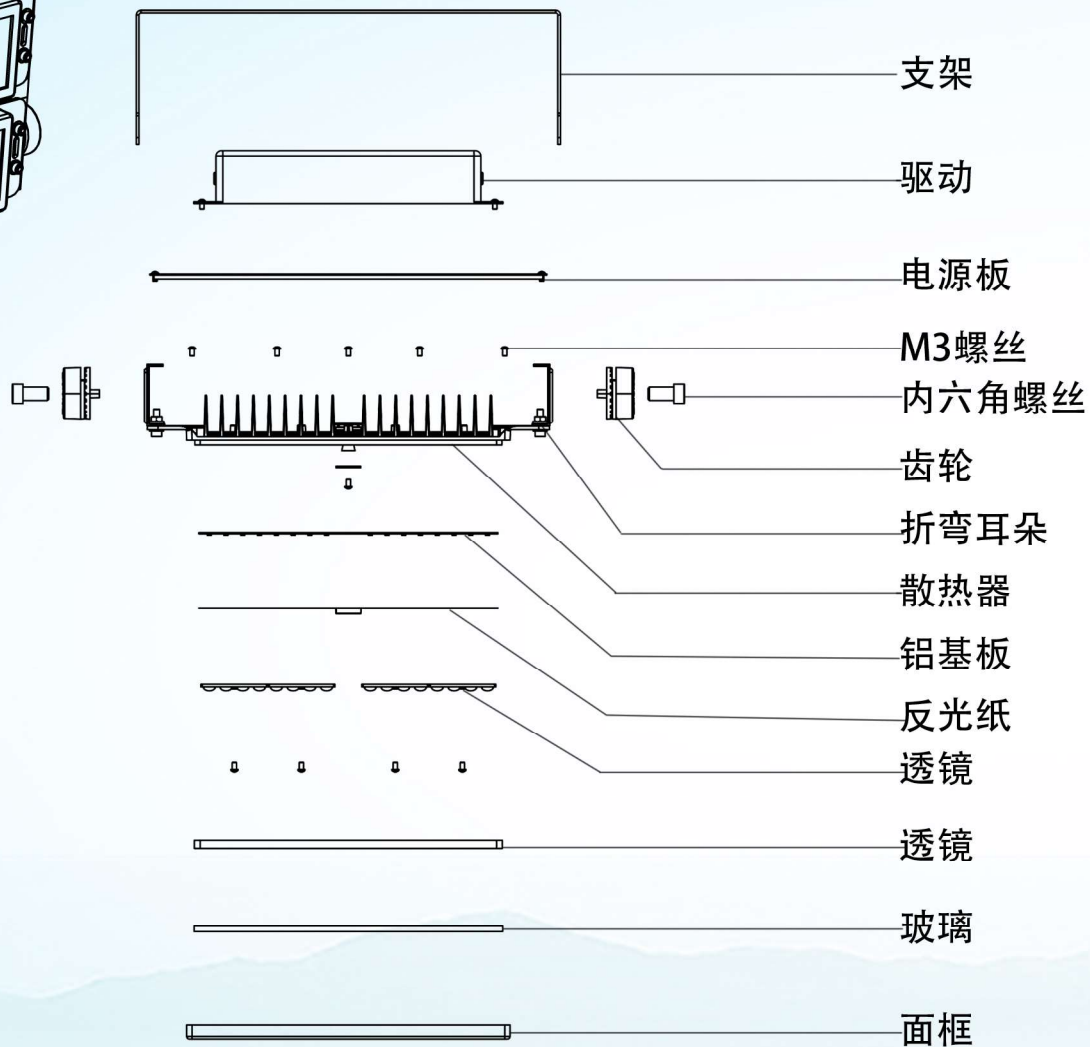
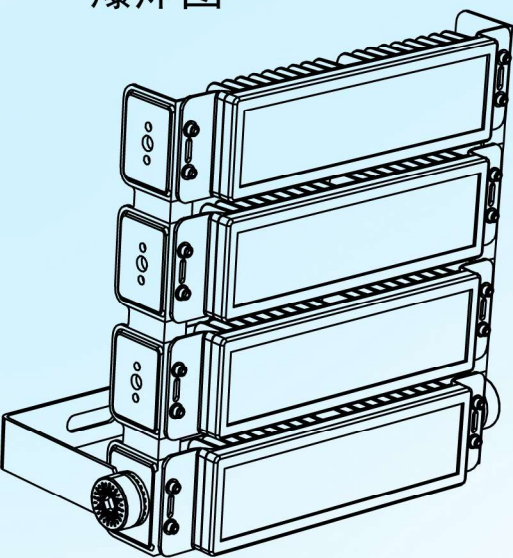

包装尺寸

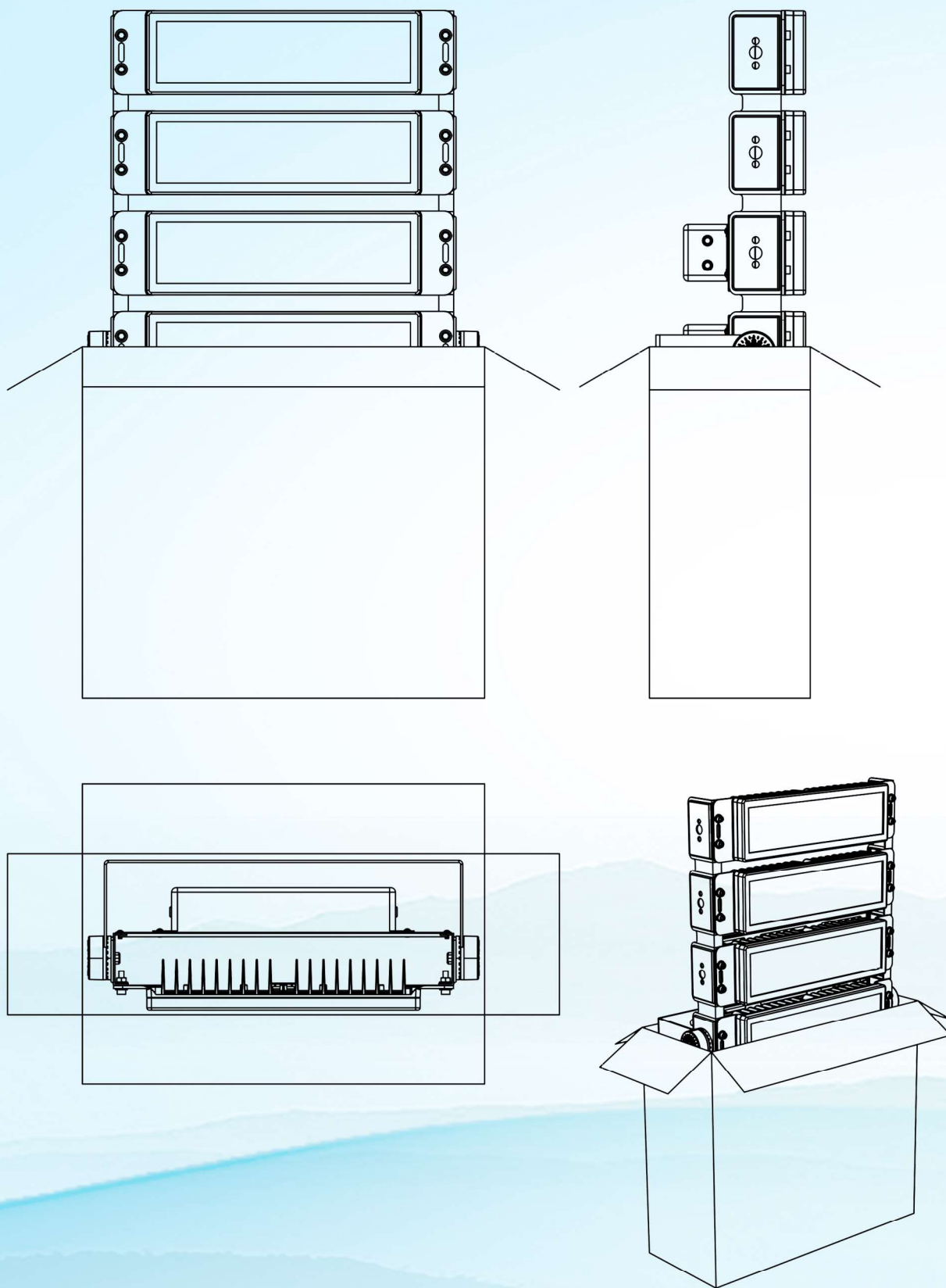

外箱尺寸：365mm*330mm*150mm